



DESCRIPTION:

With high ability to withstand the shock loading of large current, JCT1625C SCR provides high dV/dt rate with strong resistance to electromagnetic interference. It is especially recommended for use on solid state relay, motorcycle, power charger, T-tools etc. Package TO-220C is RoHS compliant.

MAIN FEATURES

| Symbol | Value | Unit |
|-------------------|-----------|------|
| $I_{T(RMS)}$ | 25 | A |
| V_{DRM}/V_{RRM} | 1600 | V |
| I_{GT} | ≤ 40 | mA |

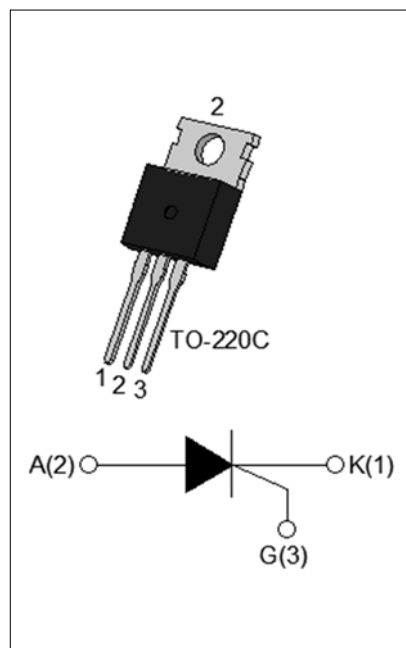

ABSOLUTE MAXIMUM RATINGS

| Parameter | Symbol | Value | Unit |
|--|--------------|---------|-------------|
| Storage junction temperature range | T_{stg} | -40-150 | $^{\circ}C$ |
| Operating junction temperature range | T_j | -40-125 | $^{\circ}C$ |
| Repetitive peak off-state voltage ($T_j=25^{\circ}C$) | V_{DRM} | 1600 | V |
| Repetitive peak reverse voltage ($T_j=25^{\circ}C$) | V_{RRM} | 1600 | V |
| Average on-state current ($T_c \leq 85^{\circ}C$) | $I_{T(AV)}$ | 16 | A |
| RMS on-state current ($T_c \leq 85^{\circ}C$) | $I_{T(RMS)}$ | 25 | A |
| Non repetitive surge peak on-state current ($t_p=10ms, T_j=25^{\circ}C$) | I_{TSM} | 280 | A |
| Non repetitive surge peak on-state current ($t_p=8.3ms, T_j=25^{\circ}C$) | | 300 | |
| I^2t value for fusing ($t_p=10ms, T_j=25^{\circ}C$) | I^2t | 392 | A^2s |
| Critical rate of rise of on-state current ($I_G=2 \times I_{GT}, f=100Hz, T_j=125^{\circ}C$) | di/dt | 200 | $A/\mu s$ |
| Peak gate current ($t_p=20\mu s, T_j=125^{\circ}C$) | I_{GM} | 5 | A |
| Average gate power dissipation ($T_j=125^{\circ}C$) | $P_{G(AV)}$ | 1 | W |

| | | | |
|--|----------|-----|----|
| Peak gate power | P_{GM} | 20 | W |
| Peak pulse voltage ($T_j=25^{\circ}\text{C}$; non-repetitive, off-state; FIG.7) | V_{pp} | 1.5 | kV |

ELECTRICAL CHARACTERISTICS ($T_j=25^{\circ}\text{C}$ unless otherwise specified)

| Symbol | Test Condition | Value | | | Unit |
|-----------|--|-------|------|------|------------------|
| | | MIN. | TYP. | MAX. | |
| I_{GT} | $V_D=12\text{V } R_L=33\Omega$ | - | - | 40 | mA |
| V_{GT} | | - | - | 1 | V |
| V_{GD} | $V_D=V_{DRM} T_j=125^{\circ}\text{C } R_L=3.3\text{K}\Omega$ | 0.2 | - | - | V |
| I_L | $I_G=1.2I_{GT}$ | - | - | 100 | mA |
| I_H | $I_T=500\text{mA}$ | - | - | 90 | mA |
| dV/dt | $V_D=1070\text{V}$ Gate Open $T_j=125^{\circ}\text{C}$ | 1000 | - | - | V/ μs |
| t_{on} | $I_G=50\text{mA } I_A=500\text{mA } I_R=50\text{mA}$ $T_j=25^{\circ}\text{C}$ | - | 7 | - | μs |
| t_{off} | | - | 100 | - | |

STATIC CHARACTERISTICS

| Symbol | Parameter | | Value(MAX.) | Unit |
|-----------|---|---------------------------|-------------|---------------|
| V_{TM} | $I_{TM}=50\text{A } t_p=380\mu\text{s}$ | $T_j=25^{\circ}\text{C}$ | 1.8 | V |
| V_{TO} | Threshold voltage | $T_j=125^{\circ}\text{C}$ | 0.74 | V |
| R_D | Dynamic resistance | $T_j=125^{\circ}\text{C}$ | 27 | m Ω |
| I_{DRM} | $V_D=V_{DRM} V_R=V_{RRM}$ | $T_j=25^{\circ}\text{C}$ | 10 | μA |
| I_{RRM} | | $T_j=125^{\circ}\text{C}$ | 4 | mA |

THERMAL RESISTANCES

| Symbol | Parameter | Value | Unit |
|---------------|--------------------------|-------|-----------------------------|
| $R_{th(j-c)}$ | junction to case(DC) | 1.1 | $^{\circ}\text{C}/\text{W}$ |
| $R_{th(j-a)}$ | junction to ambient (DC) | 55 | $^{\circ}\text{C}/\text{W}$ |

ORDERING INFORMATION

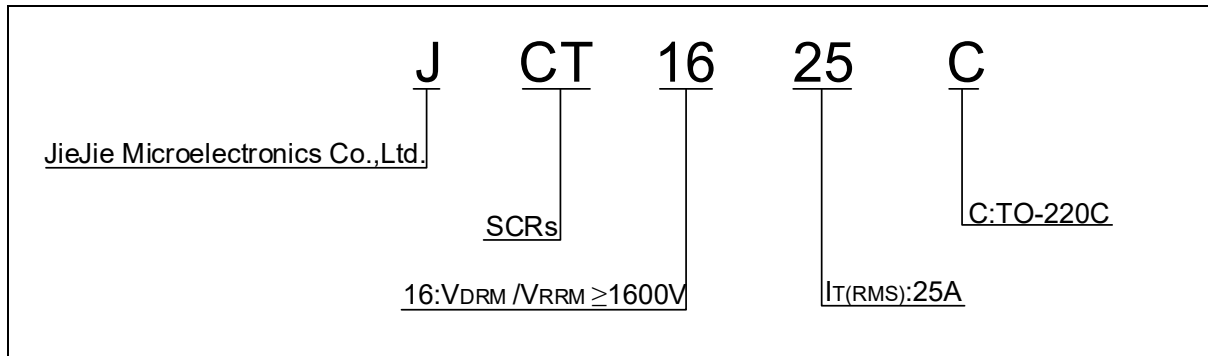

MARKING

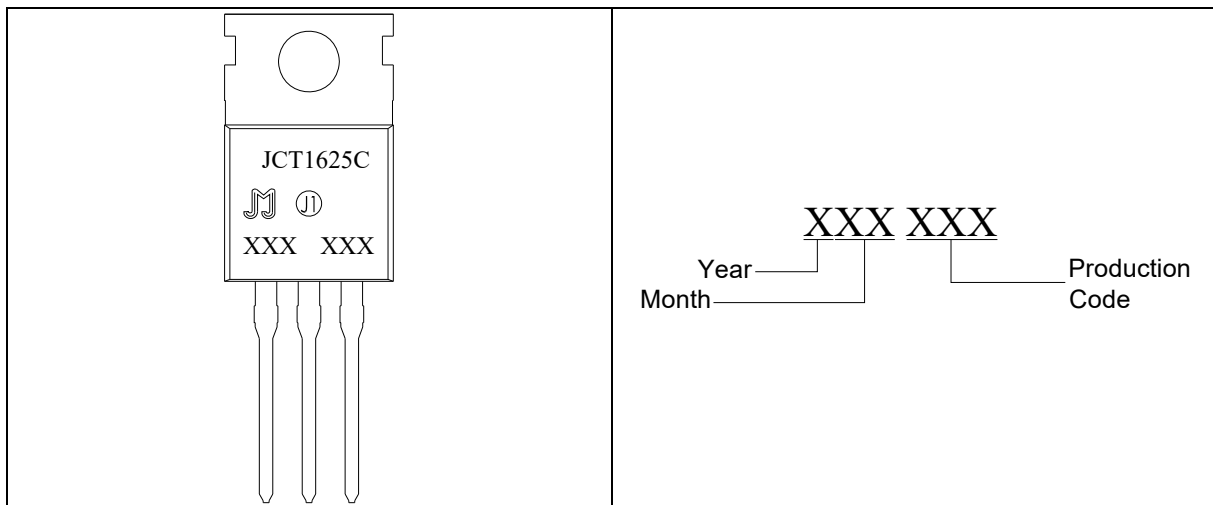

FIG.1 Maximum power dissipation versus RMS on-state current

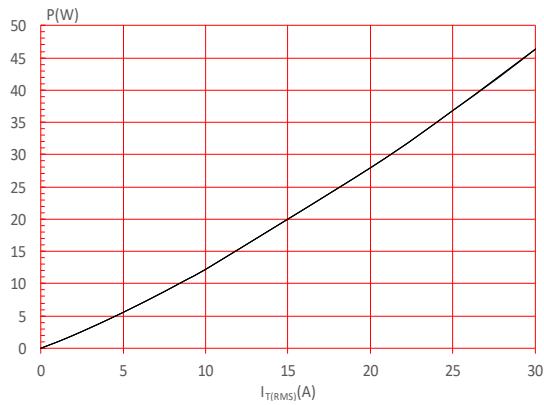

FIG.3: Surge peak on-state current versus number of cycles

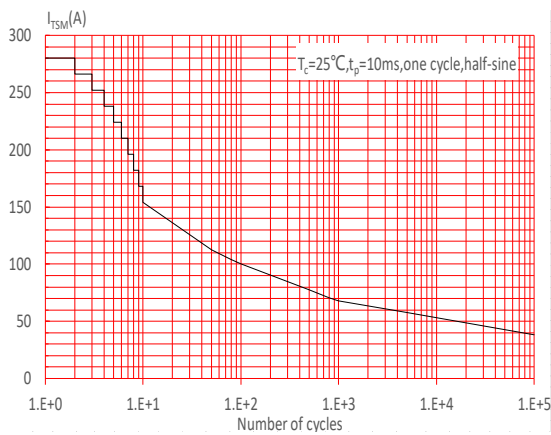

FIG.5: Non-repetitive surge peak on-state current for a sinusoidal pulse with width $t_p < 10\text{ms}$, and corresponding value of I^2t ($di/dt < 200\text{A}/\mu\text{s}$)

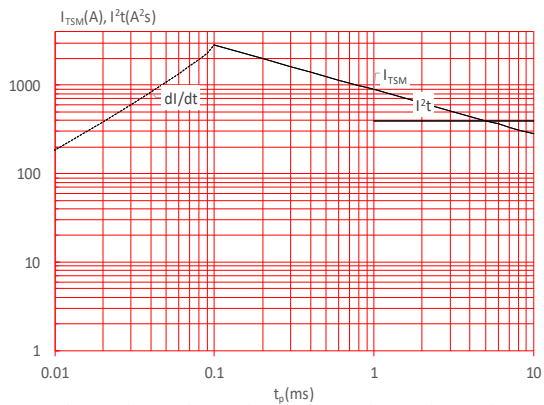

FIG.2: RMS on-state current versus case temperature

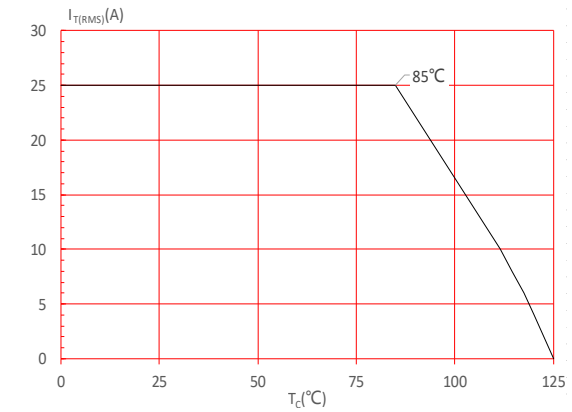

FIG.4: On-state characteristics

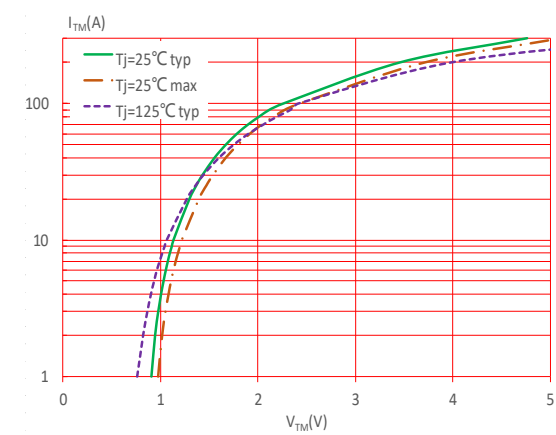

FIG.6: Relative variations of gate trigger current, holding current and latching current versus junction temperature

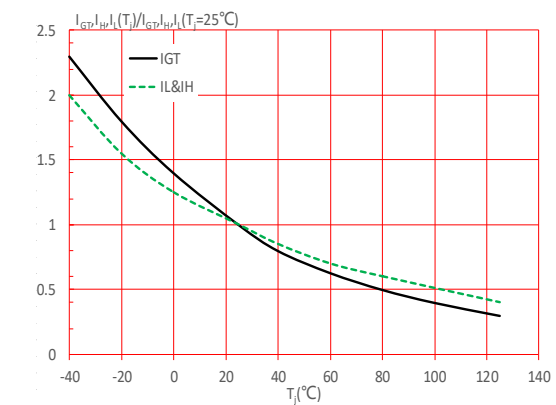
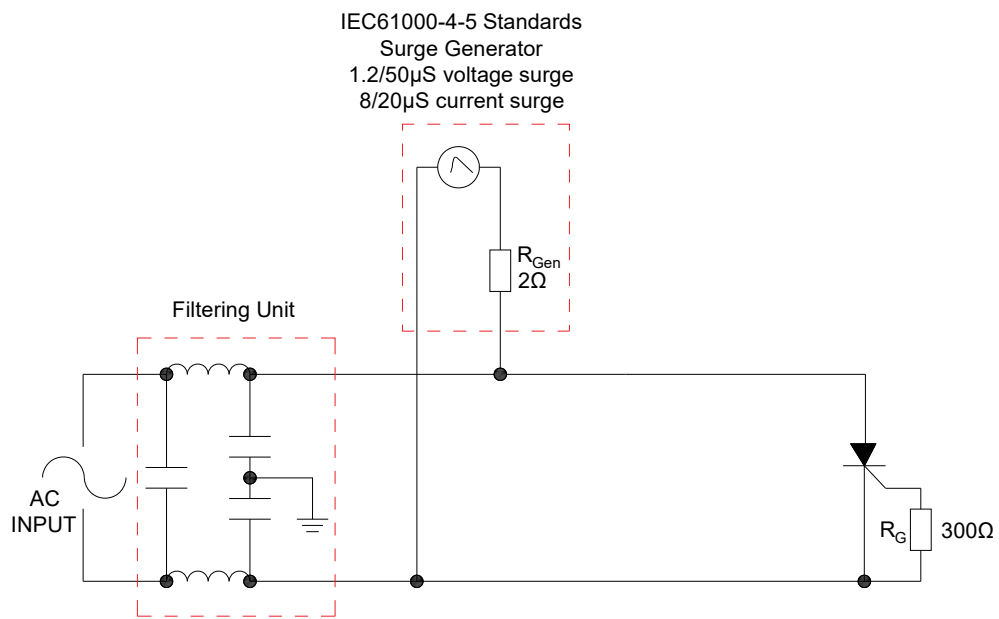

FIG.7: Test circuit for inductive and resistive loads to IEC-61000-4-5 standards.



SHAPING AND SOLDERING PARAMETERS

Refer to 《Instructions for installation of plastic-sealed in-line power devices》 released by JieJie

ORDERING INFORMATION

| Order code | Voltage V_{DRM}/V_{RRM} (V) | IGT(mA) | Package | Base qty. (pcs) | Delivery mode |
|------------|----------------------------------|---------|---------|--------------------|------------------|
| JCT1625C | 1600 | 40 | TO-220C | 50 | Tube |

Document Revision History

| Date | Revision | Changes |
|--------------|----------|-------------|
| Apr.13, 2023 | A.1.0 | Last update |

PACKAGE MECHANICAL DATA

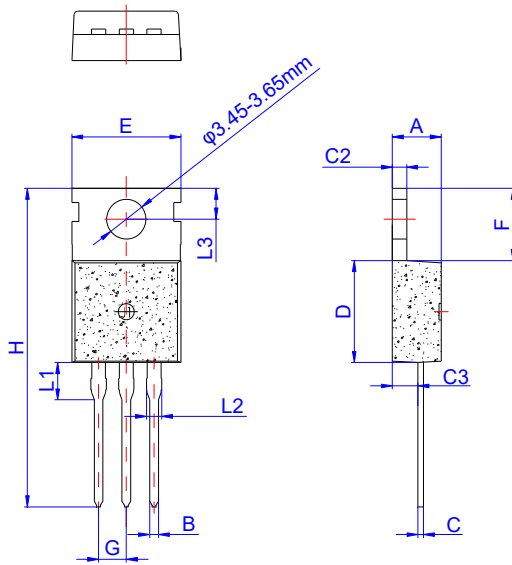

| Ref. | Dimensions | | | | | |
|------|-------------|------|------|--------|------|-------|
| | Millimeters | | | Inches | | |
| | Min. | Typ. | Max. | Min. | Typ. | Max. |
| A | 4.40 | | 4.60 | 0.173 | | 0.181 |
| B | 0.70 | | 0.90 | 0.028 | | 0.035 |
| C | 0.45 | | 0.60 | 0.018 | | 0.024 |
| C2 | 1.25 | | 1.35 | 0.049 | | 0.053 |
| C3 | 2.20 | | 2.60 | 0.087 | | 0.102 |
| D | 8.90 | | 9.90 | 0.350 | | 0.390 |
| E | 9.90 | | 10.3 | 0.390 | | 0.406 |
| F | 6.30 | | 6.90 | 0.248 | | 0.272 |
| G | 2.40 | | 2.70 | 0.094 | | 0.106 |
| H | 28.0 | | 29.8 | 1.102 | | 1.173 |
| L1 | 2.70 | | 3.30 | 0.106 | | 0.130 |
| L2 | 1.14 | | 1.70 | 0.045 | | 0.067 |
| L3 | 2.65 | | 2.95 | 0.104 | | 0.116 |

DELIVERY MODE

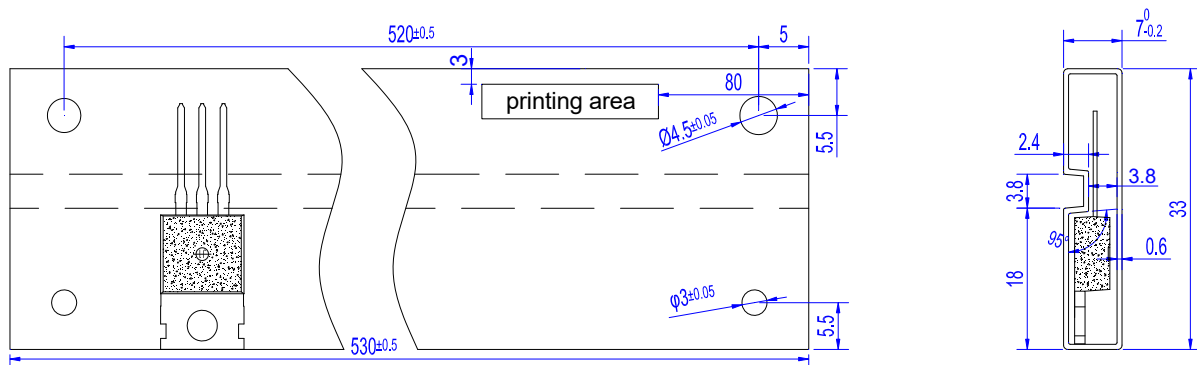

| PACKAGE | OUTLINE | TUBE (PCS) | INNER BOX (PCS) | PER CARTON |
|---------|---------|------------|-----------------|------------|
| TO-220C | TUBE | 50 | 1,000 | 5,000 |

Information furnished in this document is believed to be accurate and reliable. However, Jiangsu JieJie Microelectronics Co., Ltd. assumes no responsibility for the consequences of use without consideration for such information nor use beyond it. Information mentioned in this document is subject to change without notice, apart from that when an agreement is signed, Jiangsu JieJie complies with the agreement. Products and information provided in this document have no infringement of patents. Jiangsu JieJie assumes no responsibility for any infringement of other rights of third parties which may result from the use of such products and information. This document supersedes and replaces all information previously supplied.

 is a registered trademark of Jiangsu JieJie Microelectronics Co., Ltd. Copyright ©2023 Jiangsu JieJie Microelectronics Co., Ltd. Printed All rights reserved.